

PROJECT

TYPE

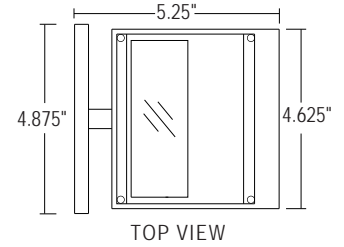
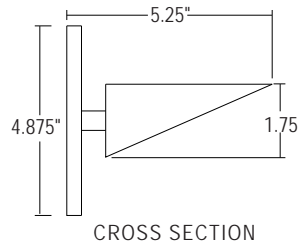
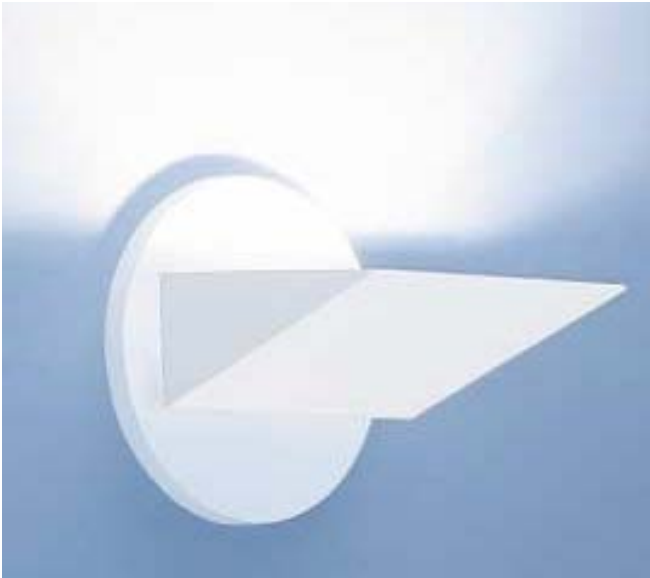

- Cast Aluminum Housing
- Round Backplate standard
- Specular Reflector
- 100 Watt or 150 Watt BA15D base Halogen Lamping
(order separately or by others)
- Clear Tempered Protective Lens standard
- Rich Powder Coat Finish
- Recommended Mounting Box: 4" Octagonal
- UL and CUL Listed Damp Location

Modifications and custom configurations are available.
Please consult factory.



ALSO AVAILABLE IN CUSTOM COLORS
AND RAW CAST ALUMINUM (NO FINISH)

ORDERING FORMAT

<u>SERIES</u>	<u>FINISH</u>	<u>OPTIONAL ACCESSORIES</u>		
WS-6215-HAL The Wedge™	WHP White Powder Coat BLP Black Powder Coat TTP Titanium Powder Coat OBP Oil Rubbed Bronze Powder Coat RAW Raw Cast Aluminum <i>(no finish)</i> CC Custom Color	<u>DIFFUSER</u> WS-SD-S1 Saw Tooth Diffuser <u>LENS</u> WS-L-S1-CL Clear Tempered Protective Lens <i>(standard with fixture)</i> WS-L-S1-FR Frosted Tempered Protective Lens	<u>ADJUSTMENT</u> WS-SK Swivel Knuckle allows for 34° adjustment <i>(17° up or down)</i> <small><i>Finish selection will match fixture unless otherwise specified.</i></small> <u>HALOGEN LAMP</u> WS-Q-100-DC Frosted 100W BA15D Base Lamp WS-Q-150-DC Frosted 150W BA15D Base Lamp	<u>BACKPLATE</u> WS-RD Round Backplate <i>(standard with fixture)</i> WS-SQ Square Backplate <small><i>Finish selection will match fixture unless otherwise specified.</i></small>



PROJECT

ADJUSTABLE HALOGEN WALL SCONCE

TYPE

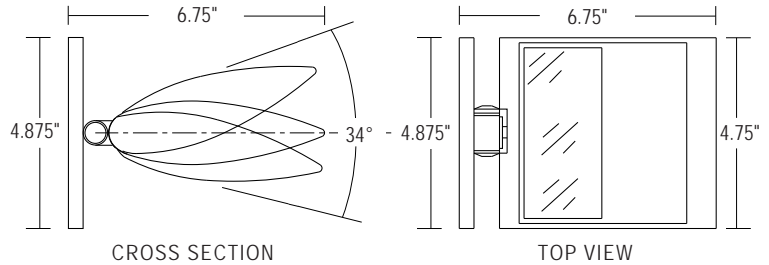

- Cast Aluminum Housing
- Round Backplate standard
- Adjustable Housing with Swivel Knuckle
allows for 34° adjustment (17° up or down)
- Specular Reflector
- 100 Watt or 150Watt BA15D base Halogen Lamping
(order separately or by others)
- Clear Tempered Protective Lens standard
- Rich Powder Coat Finish
- Recommended Mounting Box: 4" Octagonal
- UL and CUL Listed Damp Location



Modifications and custom configurations are available.
 Please consult factory.

ALSO AVAILABLE IN CUSTOM COLORS
 AND RAW CAST ALUMINUM (NO FINISH)

ORDERING FORMAT

SERIES

WS-6230-HAL
 The Varial™

FINISH

- WHP**
 White Powder Coat
- BLP**
 Black Powder Coat
- TTP**
 Titanium Powder Coat
- OBP**
 Oil Rubbed Bronze Powder Coat
- RAW**
 Raw Cast Aluminum
(no finish)
- CC**
 Custom Color

OPTIONAL ACCESSORIES

DIFFUSER

WS-SD-S1
 Saw Tooth Diffuser

LENS

WS-L-S1-CL
 Clear Tempered Protective Lens
(standard with fixture)

WS-L-S1-FR
 Frosted Tempered Protective Lens

BACKPLATE

WS-RD
 Round Backplate
(standard with fixture)

WS-SQ
 Square Backplate

*Finish selection will match fixture
 unless otherwise specified.*

HALOGEN LAMP

WS-Q-100-DC
 Frosted 100W BA15D Base Lamp

WS-Q-150-DC
 Frosted 150W BA15D Base Lamp



PROJECT

TYPE

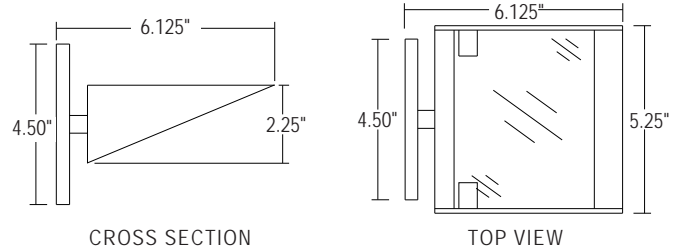
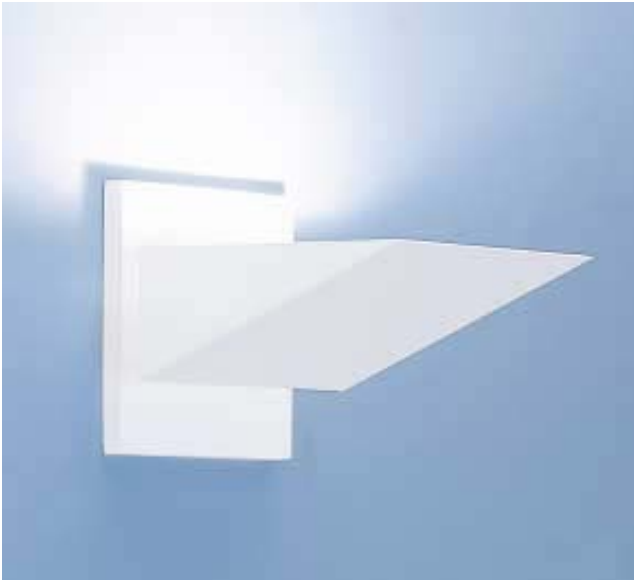

- Formed Steel Housing
- Square Backplate standard
- Specular Reflector
- 100 Watt or 150 Watt BA15D base Halogen Lamping
(order separately or by others)
- Clear Tempered Protective Lens standard
- Rich Powder Coat Finish
- Recommended Mounting Box: 4" Octagonal
- UL and CUL Listed Damp Location



Modifications and custom configurations are available.
Please consult factory.

ALSO AVAILABLE IN CUSTOM COLORS

ORDERING FORMAT

SERIES

WS-7215-HAL
The Wedge Lens™

FINISH

- WHP
White Powder Coat
- BLP
Black Powder Coat
- TTP
Titanium Powder Coat
- OBP
Oil Rubbed Bronze Powder Coat
- CC
Custom Color

OPTIONAL ACCESSORIES

DIFFUSER

WS-SD-S3
Saw Tooth Diffuser

LENS

WS-L-S3-CL
Clear Tempered Protective Lens
(standard with fixture)

WS-L-S3-FR
Frosted Tempered Protective Lens

WS-L-S3-MP-CL
Clear Micro Prismatic Lens

WS-L-S3-MP-FR
Frosted Micro Prismatic Lens

WS-L-S3-DP-CL
Clear Diamond Pattern Lens

ADJUSTMENT

WS-SK
Swivel Knuckle
*allows for 34° adjustment
(17° up or down)*

*Finish selection will match fixture unless
otherwise specified.*

HALOGEN LAMP

WS-Q-100-DC
Frosted 100W BA15D Base Lamp

WS-Q-150-DC
Frosted 150W BA15D Base Lamp

BACKPLATE

WS-SQ
Square Backplate
(standard with fixture)

WS-RD
Round Backplate

*Finish selection will match fixture
unless otherwise specified.*



PROJECT

TYPE

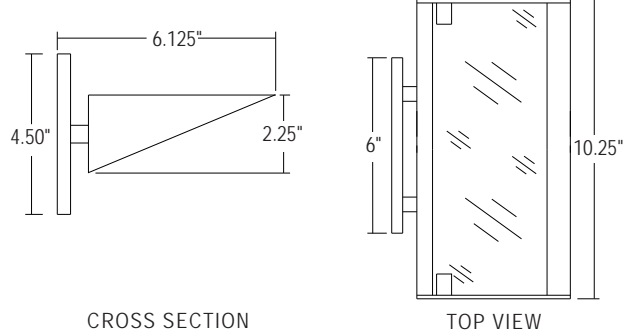
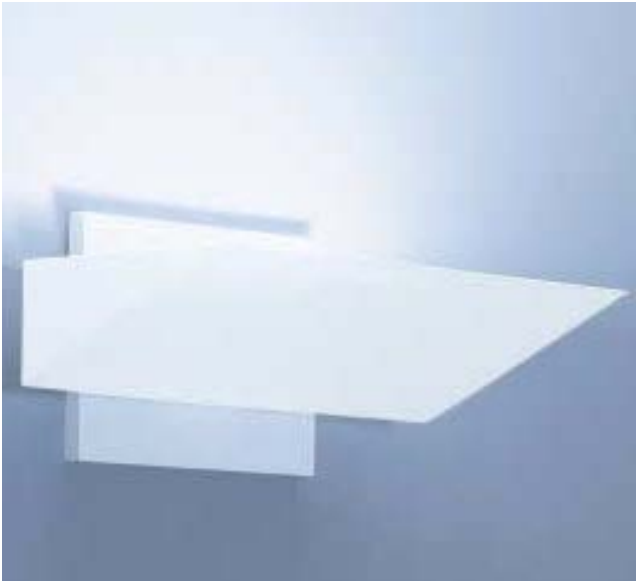

- Formed Steel Housing
- Rectangular Backplate standard
- Specular Reflector
- 100 Watt or 150Watt BA15D base Halogen Lamping
(requires 2) (order separately or by others)
- Clear Tempered Protective Lens standard
- Rich Powder Coat Finish
- Recommended Mounting Box: 4" Octagonal
- UL and CUL Listed Damp Location



Modifications and custom configurations are available.
Please consult factory.

ALSO AVAILABLE IN CUSTOM COLORS

ORDERING FORMAT

SERIES

WS-7230-HAL
The Double
Wedge Lens™

FINISH

- WHP
White Powder Coat
- BLP
Black Powder Coat
- TTP
Titanium Powder Coat
- OBP
Oil Rubbed Bronze Powder Coat
- CC
Custom Color

OPTIONAL ACCESSORIES

DIFFUSER

WS-SD-S4
Saw Tooth Diffuser

LENS

WS-L-S4-CL
Clear Tempered Protective Lens
(standard with fixture)

WS-L-S4-FR
Frosted Tempered Protective Lens

WS-L-S4-MP-CL
Clear Micro Prismatic Lens

WS-L-S4-MP-FR
Frosted Micro Prismatic Lens

WS-L-S4-DP-CL
Clear Diamond Pattern Lens

ADJUSTMENT

WS-SK
Swivel Knuckle *(requires 2)*
allows for 34° adjustment
(17° up or down)

Finish selection will match fixture unless otherwise specified.

HALOGEN LAMP

WS-Q-100-DC
Frosted 100W BA15D Base Lamp

WS-Q-150-DC
Frosted 150W BA15D Base Lamp

BACKPLATE

WS-RT
Rectangular Backplate
(standard with fixture)

Finish selection will match fixture unless otherwise specified.



PROJECT

TYPE

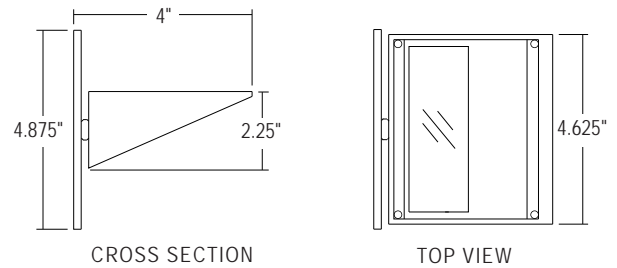

- Meets ADA Requirements for Wall Sconces
- Cast Aluminum Housing
- Round Low Profile Backplate standard
- Specular Reflector
- 100 Watt BA15D base Halogen Lamping
(order separately or by others)
- Clear Tempered Protective Lens standard
- Rich Powder Coat Finish
- Recommended Mounting Box: 4" Octagonal
- UL and CUL Listed Damp Location

Modifications and custom configurations are available.
 Please consult factory.



ALSO AVAILABLE IN CUSTOM COLORS

ORDERING FORMAT

SERIES

WS-8815-HAL
 The ADA Wedge™

FINISH

WHP
 White Powder Coat

BLP
 Black Powder Coat

TTP
 Titanium Powder Coat

OBP
 Oil Rubbed Bronze Powder Coat

CC
 Custom Color

OPTIONAL ACCESSORIES

DIFFUSER

WS-SD-S1
 Saw Tooth Diffuser

HALOGEN LAMP

WS-Q-100-DC
 Frosted 100W BA15D Base Lamp

LENS

WS-L-S1-CL
 Clear Tempered Protective Lens
(standard with fixture)

WS-L-S1-FR
 Frosted Tempered Protective Lens



PROJECT

TYPE

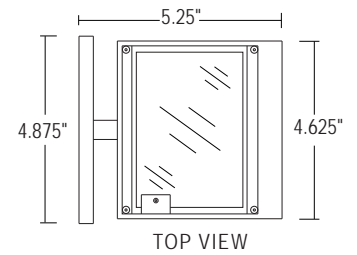
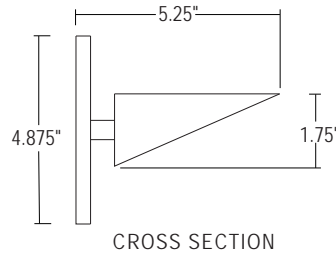
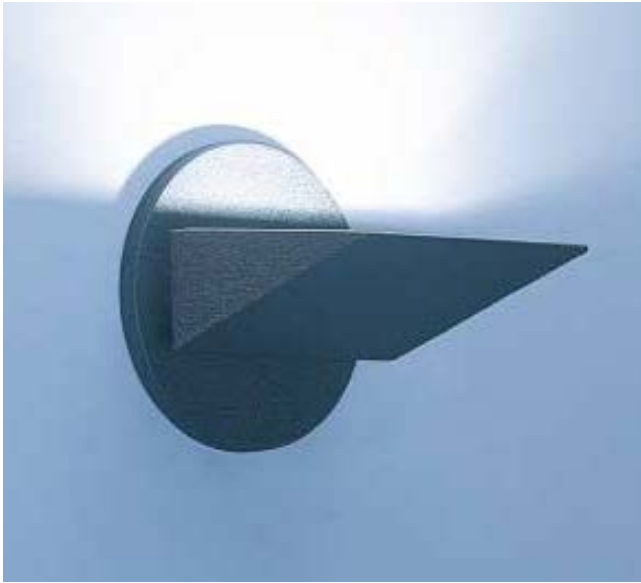

- Cast Aluminum Housing
- Round Backplate standard
- 2,700 Lumens, 26 Watts standard
- 105 Lumens per Watt
- 0-10V Dimming Compatible
- Universal Voltage (120-277V)
- Clear Micro Prismatic Lens standard
- Rich Powder Coat Finish
- Recommended Mounting Box: 4" Octagonal, min. 2" deep
- UL and CUL Listed Damp Location

Modifications and custom configurations are available.
Additional Kelvin and CRI options are available.
Please consult factory.



ALSO AVAILABLE IN CUSTOM COLORS
AND RAW CAST ALUMINUM (NO FINISH)

ORDERING FORMAT

<u>SERIES</u>	<u>DIMMING</u>	<u>KELVIN</u>	<u>CRI</u>	<u>FINISH</u>	<u>OPTIONAL ACCESSORIES</u>
WS-6215-LED-Z10 The LED Wedge™	U 0-10V Dimming to 10%	27 2700K	90 90+	WHP White Powder Coat	DIFFUSER WS-SD-S2 Saw Tooth Diffuser
	ELSD-U eldoLED SOLOdrive 0-10V Dimming to 0.1% (remote only)	30 3000K		BLP Black Powder Coat	ADJUSTMENT WS-SK Swivel Knuckle allows for 34° adjustment (17° up or down)
		35 3500K		TTP Titanium Powder Coat	<small>Finish selection will match fixture unless otherwise specified.</small>
				OBP Oil Rubbed Bronze Powder Coat	LENS WS-L-S2-MP-CL Clear Micro Prismatic Lens (standard with fixture)
				RAW Raw Cast Aluminum (no finish)	WS-L-S2-MP-FR Frosted Micro Prismatic Lens
				CC Custom Color	BACKPLATE WS-RD Round Backplate (standard with fixture)
					WS-SQ Square Backplate
					<small>Finish selection will match fixture unless otherwise specified.</small>



WS 6215-LED-Z10-DW
The LED Wedge™
DIM TO WARM LED WALL SCONCE

PROJECT

TYPE

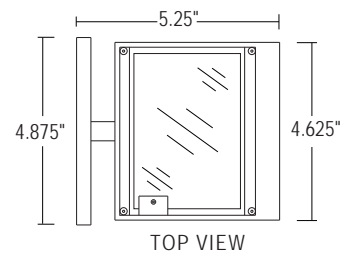
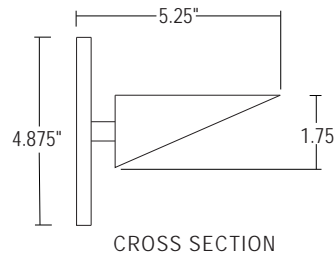

- Cast Aluminum Housing
- Round Backplate standard
- 2,800 Lumens, 24 Watts standard
- 117 Lumens per Watt
- 3000K - 1800K Range
- 0-10V Dimming Compatible
- Universal Voltage (120-277V)
- Clear Micro Prismatic Lens standard
- Rich Powder Coat Finish
- Recommended Mounting Box: 4" Octagonal, min. 2" deep
- UL and CUL Listed Damp Location

Modifications and custom configurations are available.
Please consult factory.



ALSO AVAILABLE IN CUSTOM COLORS
AND RAW CAST ALUMINUM (NO FINISH)

ORDERING FORMAT

<u>SERIES</u>	<u>DIMMING</u>	<u>KELVIN RANGE</u>	<u>CRI</u>	<u>FINISH</u>	<u>OPTIONAL ACCESSORIES</u>	
WS-6215-LED-Z10 The LED Wedge™	U 0-10V Dimming to 10% ELSD-U eldoLED SOLOdrive 0-10V Dimming to 0.1% (remote only)	DW Dim to Warm 3000K to 1800K	90 90+	WHP White Powder Coat BLP Black Powder Coat TTP Titanium Powder Coat OBP Oil Rubbed Bronze Powder Coat RAW Raw Cast Aluminum (no finish) CC Custom Color	<u>DIFFUSER</u> WS-SD-S2 Saw Tooth Diffuser <u>LENS</u> WS-L-S2-MP-CL Clear Micro Prismatic Lens (standard with fixture) WS-L-S2-MP-FR Frosted Micro Prismatic Lens	<u>ADJUSTMENT</u> WS-SK Swivel Knuckle allows for 34° adjustment (17° up or down) <small>Finish selection will match fixture unless otherwise specified.</small> <u>BACKPLATE</u> WS-RD Round Backplate (standard with fixture) WS-SQ Square Backplate <small>Finish selection will match fixture unless otherwise specified.</small>



WS 6215-LED-ELVT-1-DW
The LED Wedge™
DIM TO WARM LED WALL SCONCE

PROJECT

TYPE

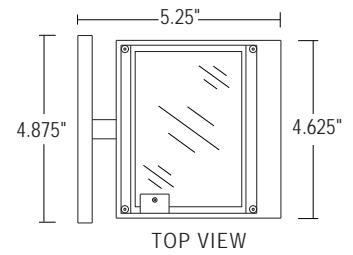
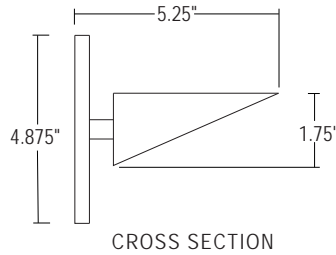
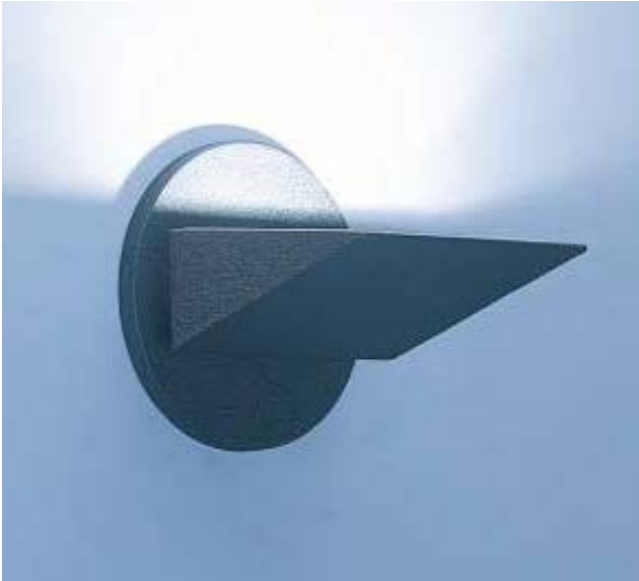

- Cast Aluminum Housing
- Round Backplate standard
- 2,800 Lumens, 24 Watts standard
- 117 Lumens per Watt
- 3000K - 1800K Range
- 120V AC ELV/TRIAC LED Dimming Compatible
- Dimming to 5% standard
- Clear Micro Prismatic Lens standard
- Rich Powder Coat Finish
- Recommended Mounting Box: 4" Octagonal, min. 2" deep
- UL and CUL Listed Damp Location

Modifications and custom configurations are available.
Please consult factory.



ALSO AVAILABLE IN CUSTOM COLORS
AND RAW CAST ALUMINUM (NO FINISH)

ORDERING FORMAT

SERIES

WS-6215-LED-ELVT-1
The LED Wedge™

KELVIN RANGE

DW
Dim to Warm
3000K to 1800K

CRI

90
90+

FINISH

- WHP**
White Powder Coat
- BLP**
Black Powder Coat
- TTP**
Titanium Powder Coat
- OBP**
Oil Rubbed Bronze Powder Coat
- RAW**
Raw Cast Aluminum
(no finish)
- CC**
Custom Color

OPTIONAL ACCESSORIES

DIFFUSER

WS-SD-S2
Saw Tooth Diffuser

LENS

- WS-L-S2-MP-CL**
Clear Micro Prismatic Lens
(standard with fixture)
- WS-L-S2-MP-FR**
Frosted Micro Prismatic Lens

ADJUSTMENT

WS-SK
Swivel Knuckle
allows for 34° adjustment
(17° up or down)

Finish selection will match fixture unless otherwise specified.

BACKPLATE

- WS-RD**
Round Backplate
(standard with fixture)
- WS-SQ**
Square Backplate

Finish selection will match fixture unless otherwise specified.



PROJECT

TYPE

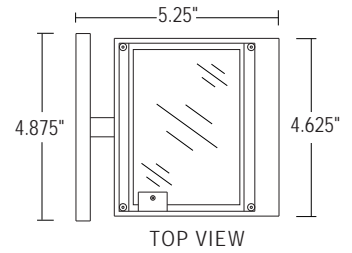
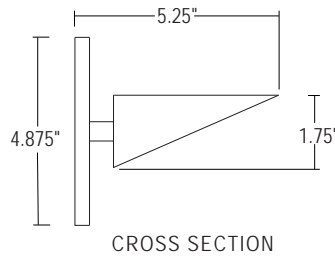
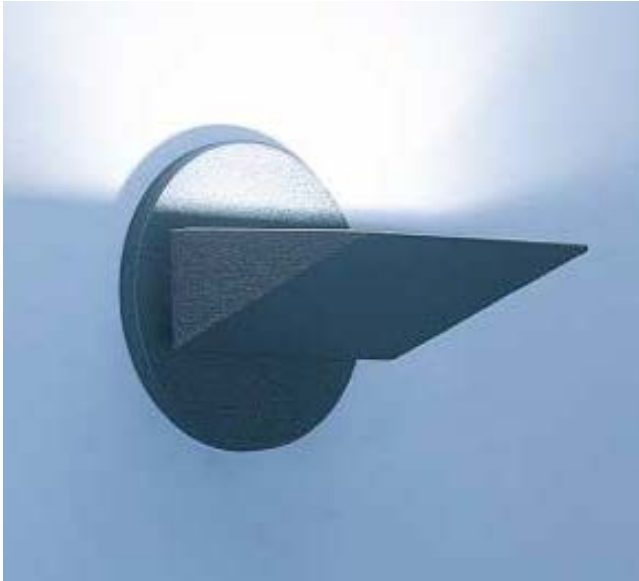

- Cast Aluminum Housing
- Round Backplate standard
- 2,600 Lumens, 20 Watts standard
- 130 Lumens per Watt
- 120V AC ELV LED Dimming Compatible
- Dimming to 15% standard
(Dimming to 0% possible with select controls)
- Clear Micro Prismatic Lens standard
- Rich Powder Coat Finish
- Recommended Mounting Box: 4" Octagonal
- UL and CUL Listed Damp Location

Modifications and custom configurations are available.
Additional Kelvin and CRI options are available.
Please consult factory.



ALSO AVAILABLE IN CUSTOM COLORS
AND RAW CAST ALUMINUM (NO FINISH)

ORDERING FORMAT

<u>SERIES</u>	<u>KELVIN</u>	<u>CRI</u>	<u>FINISH</u>	<u>OPTIONAL ACCESSORIES</u>	
WS-6215-LED-ELV-1 The LED Wedge™	27 2700K	90 90+	WHP White Powder Coat	DIFFUSER	ADJUSTMENT
	30 3000K		BLP Black Powder Coat	WS-SD-S2 Saw Tooth Diffuser	WS-SK Swivel Knuckle allows for 34° adjustment (17° up or down)
	35 3500K		TTP Titanium Powder Coat		<i>Finish selection will match fixture unless otherwise specified.</i>
			OBP Oil Rubbed Bronze Powder Coat	LENS	BACKPLATE
			RAW Raw Cast Aluminum (no finish)	WS-L-S2-MP-CL Clear Micro Prismatic Lens (standard with fixture)	WS-RD Round Backplate (standard with fixture)
			CC Custom Color	WS-L-S2-MP-FR Frosted Micro Prismatic Lens	WS-SQ Square Backplate
					<i>Finish selection will match fixture unless otherwise specified.</i>



WS 6230-LED-ELV-1
The LED Varial™
 ADJUSTABLE LED WALL SCONCE

PROJECT

TYPE

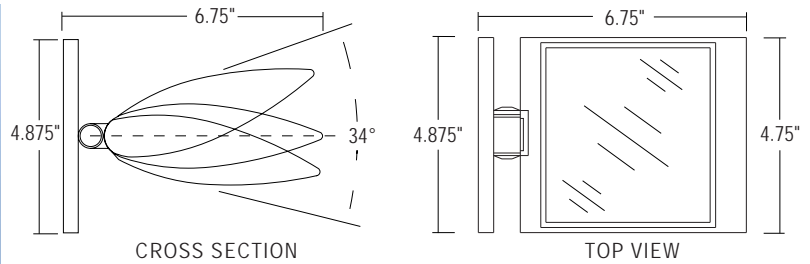

- Cast Aluminum Housing
- Round Backplate standard
- Adjustable Housing with Swivel Knuckle
allows for 34° adjustment (17° up or down)
- 2,600 Lumens, 20 Watts
- 130 Lumens per Watt
- 120V AC ELV LED Dimming Compatible
- Dimming to 15% standard
 (Dimming to 0% possible with select controls)
- Clear Micro Prismatic Lens standard
- Rich Powder Coat Finish
- Recommended Mounting Box: 4" Octagonal
- UL and CUL Listed Damp Location



ALSO AVAILABLE IN CUSTOM COLORS
 AND RAW CAST ALUMINUM (NO FINISH)

Modifications and custom configurations are available.
 Additional Kelvin and CRI options are available.
 Please consult factory.

ORDERING FORMAT

<u>SERIES</u>	<u>KELVIN</u>	<u>CRI</u>	<u>FINISH</u>	<u>OPTIONAL ACCESSORIES</u>	
WS 6230-LED-ELV-1 The LED Varial™	27 2700K	90 90+	WHP White Powder Coat	<u>DIFFUSER</u> WS-SD-S2 Saw Tooth Diffuser	<u>BACKPLATE</u> WS-RD Round Backplate <i>(standard with fixture)</i>
	30 3000K		BLP Black Powder Coat		WS-SQ Square Backplate
	35 3500K		TTP Titanium Powder Coat		<small><i>Finish selection will match fixture unless otherwise specified.</i></small>
			OBP Oil Rubbed Bronze Powder Coat	<u>LENS</u> WS-L-S2-MP-CL Clear Micro Prismatic Lens <i>(standard with fixture)</i>	
			RAW Raw Cast Aluminum <i>(no finish)</i>	WS-L-S2-MP-FR Frosted Micro Prismatic Lens	
			CC Custom Color		



WS 7215-LED-ELV-1
The LED Wedge Lens™
LED WALL SCONCE

PROJECT

TYPE

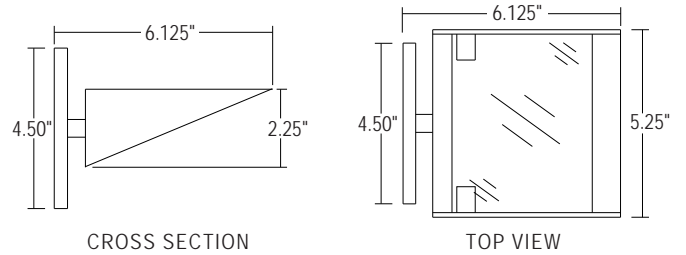
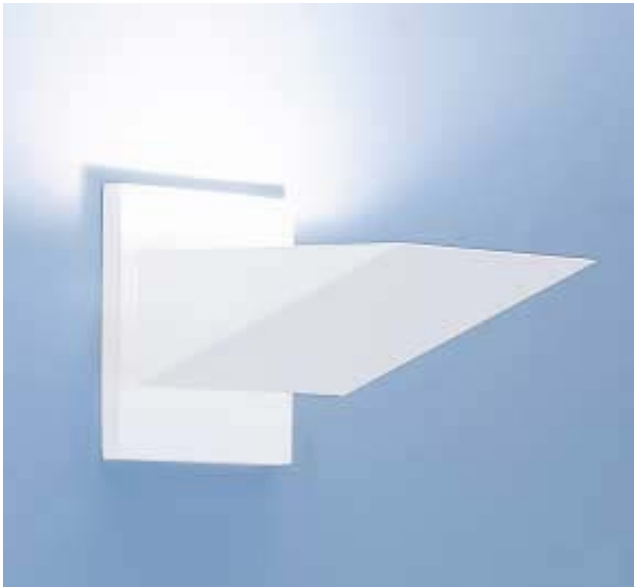

- Formed Steel Housing
- Square Backplate
- 2,600 Lumens, 20 Watts
- 130 Lumens per Watt
- 120V AC ELV LED Dimming Compatible
- Dimming to 15% standard
(Dimming to 0% possible with select controls)
- Clear Micro Prismatic Lens standard
- Rich Powder Coat Finish
- Recommended Mounting Box: 4" Octagonal
- UL and CUL Listed Damp Location

Modifications and custom configurations are available.
Additional Kelvin and CRI options are available.
Please consult factory.



ALSO AVAILABLE IN CUSTOM COLORS

ORDERING FORMAT

<u>SERIES</u>	<u>KELVIN</u>	<u>CRI</u>	<u>FINISH</u>	<u>OPTIONAL ACCESSORIES</u>	
WS 7215-LED-ELV-1 The LED Wedge Lens™	27 2700K	90 90+	WHP White Powder Coat	<u>DIFFUSER</u>	<u>ADJUSTMENT</u>
	30 3000K		BLP Black Powder Coat	WS-SD-S3 Saw Tooth Diffuser	WS-SK Swivel Knuckle allows for 34° adjustment (17° up or down)
	35 3500K		TTP Titanium Powder Coat		<small>Finish selection will match fixture unless otherwise specified.</small>
			OBP Oil Rubbed Bronze Powder Coat	<u>LENS</u>	<u>BACKPLATE</u>
			CC Custom Color	WS-L-S3-MP-CL Clear Micro Prismatic Lens <i>(standard with fixture)</i>	WS-SQ Square Backplate <i>(standard with fixture)</i>
				WS-L-S3-MP-FR Frosted Micro Prismatic Lens	WS-RD Round Backplate
				WS-L-S3-DP-CL Clear Diamond Pattern Lens	<small>Finish selection will match fixture unless otherwise specified.</small>



PROJECT

TYPE

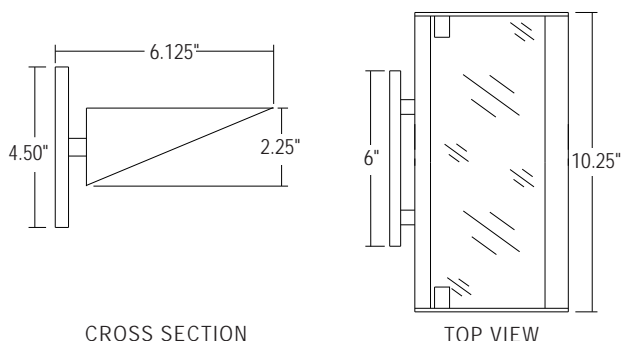
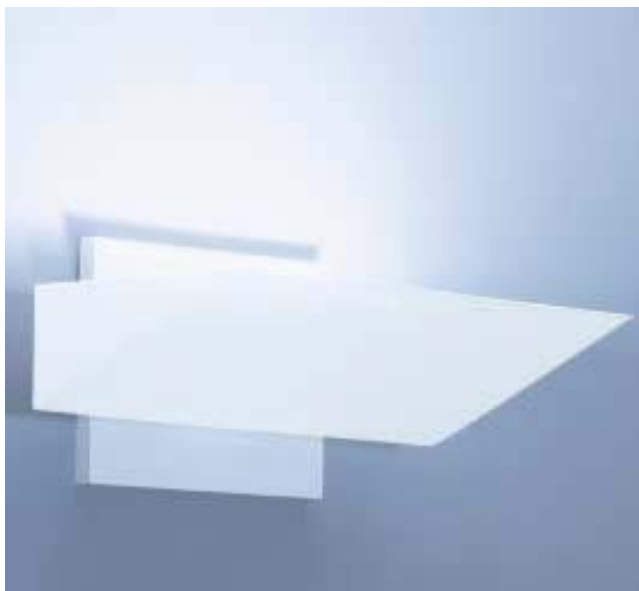

- Formed Steel Housing
- Rectangular Backplate
- 3,900 Lumens, 30 Watts
- 130 Lumens per Watt
- 120V AC ELV LED Dimming Compatible
- Dimming to 15% standard
(Dimming to 0% possible with select controls)
- Clear Micro Prismatic Lens standard
- Rich Powder Coat Finish
- Recommended Mounting Box: 4" Octagonal
- UL and CUL Listed Damp Location

Modifications and custom configurations are available.
 Additional Kelvin and CRI options are available.
 Please consult factory.

ALSO AVAILABLE IN CUSTOM COLORS

ORDERING FORMAT

<u>SERIES</u>	<u>KELVIN</u>	<u>CRI</u>	<u>FINISH</u>	<u>OPTIONAL ACCESSORIES</u>	
WS 7230-LED-ELV-1 The Double LED Wedge Lens™	27 2700K	90 90+	WHP White Powder Coat	<u>DIFFUSER</u> WS-SD-S4 Saw Tooth Diffuser	<u>ADJUSTMENT</u> WS-SK Swivel Knuckle (requires 2) allows for 34° adjustment (17° up or down)
	30 3000K		BLP Black Powder Coat		<small>Finish selection will match fixture unless otherwise specified.</small>
	35 3500K		TTP Titanium Powder Coat	<u>LENS</u> WS-L-S4-MP-CL Clear Micro Prismatic Lens (standard with fixture)	<u>BACKPLATE</u> WS-RT Rectangular Backplate (standard with fixture)
			OBP Oil Rubbed Bronze Powder Coat	WS-L-S4-MP-FR Frosted Micro Prismatic Lens	<small>Finish selection will match fixture unless otherwise specified.</small>
			CC Custom Color	WS-L-S4-DP-CL Clear Diamond Pattern Lens	



RICH, DURABLE POWDER COAT FINISHES



WHP
WHITE POWDER COAT



BLP
BLACK POWDER COAT

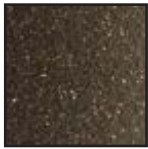

OBP
OIL RUBBED BRONZE POWDER COAT



TTP
TITANIUM POWDER COAT

ALSO AVAILABLE IN
RAW RAW CAST ALUMINUM
(NO FINISH)
CC CUSTOM COLORS

COMPUTER DESIGNED SPECULAR REFLECTORS (halogen fixtures only)

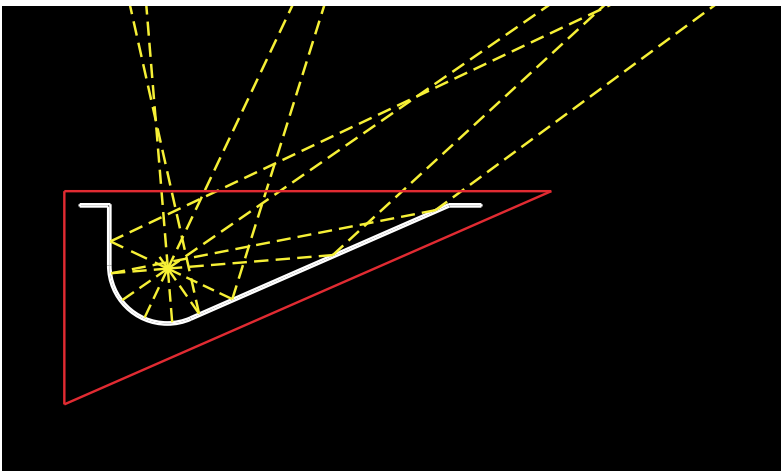

LED FIXTURES DESIGNED TO PERFORM AS OUR HALOGEN FIXTURES

SPECIFICATION GRADE CONSTRUCTION



SPECIFICATION GRADE
CAST ALUMINUM



SPECIFICATION GRADE
FORMED STEEL

WALL SCONCE BACKPLATES

OUR WALL SCONCE FIXTURES COME STANDARD WITH ROUND, SQUARE OR RECTANGULAR BACKPLATES IN MATCHING POWDERCOAT FINISHES

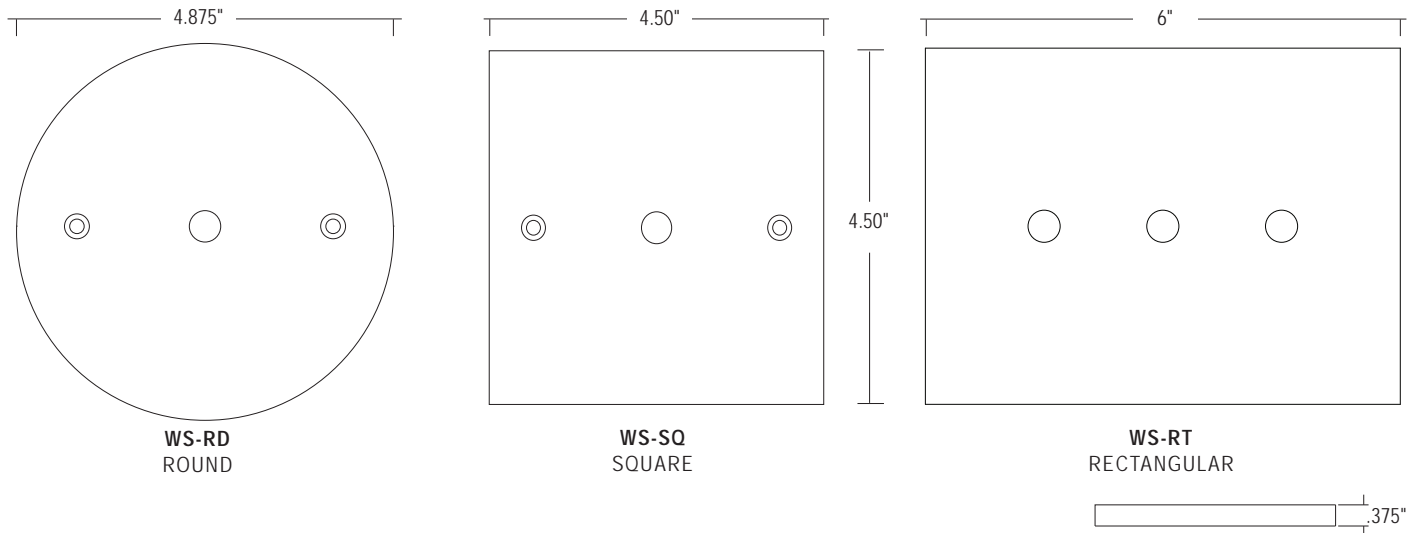

SWIVEL KNUCKLES

OUR OPTIONAL SWIVEL KNUCKLE ALLOWS FOR 34° ADJUSTMENT (17° UP OR DOWN) FOR OPTIMUM LIGHT DIRECTION

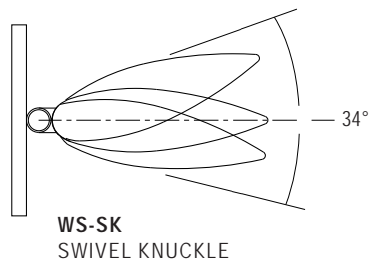

CUSTOMIZATION

CUSTOM ACCESSORIES ARE AVAILABLE INCLUDING STEMS, SHIELDING, SHROUDS AND BACKPLATES. PLEASE CONSULT THE FACTORY ON YOUR CUSTOM DESIGNED PROJECT.

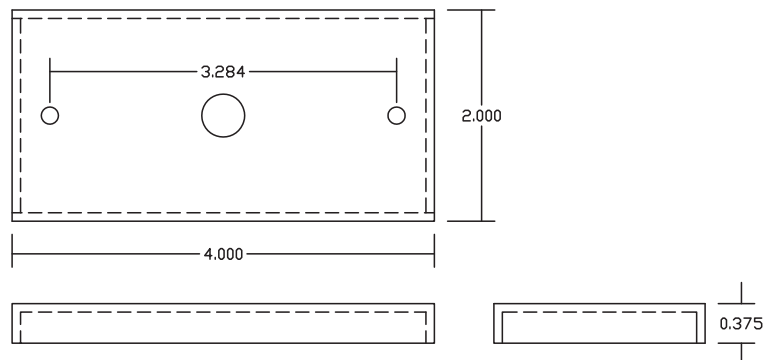
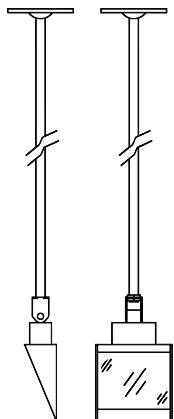

	ADJUSTMENTS		BACKPLATES	
	SWIVEL KNUCKLE		STANDARD BACKPLATE	OPTIONAL BACKPLATE
WEDGE™				
WS-6215-HAL	WS-SK		WS-RD	WS-SQ
WS-6215-LED-Z10	WS-SK		WS-RD	WS-SQ
WS-6215-LED-Z10-DW	WS-SK		WS-RD	WS-SQ
WS-6215-LED-ELV-1	WS-SK		WS-RD	WS-SQ
WS-6215-LED-ELVT-1-DW	WS-SK		WS-RD	WS-SQ
VARIAL™				
WS-6230-HAL	INCL.		WS-RD	WS-SQ
WS-6230-LED-ELV-1	INCL.		WS-RD	WS-SQ
WEDGE LENS™				
WS-7215-HAL	WS-SK		WS-SQ	WS-RD
WS-7215-LED-ELV-1	WS-SK		WS-SQ	WS-RD
DOUBLE WEDGE LENS™				
WS-7230-HAL	WS-SK		WS-RT	N/A
WS-7230-LED-ELV-1	WS-SK <i>(requires 2)</i>		WS-RT	N/A
ADA WEDGE™				
WS-8815-HAL	N/A		WS-RD-LP	N/A

BACKPLATES AND SWIVEL KNUCKLES ARE AVAILABLE IN MATCHING POWDERCOAT FINISHES

	DIFFUSERS		LENSES				
	SAW TOOTH DIFFUSER		CLEAR TEMPERED	FROSTED TEMPERED	CLEAR MICRO PRISMATIC	FROSTED MICRO PRISMATIC	CLEAR DIAMOND PATTERN
WEDGE™							
WS-6215-HAL	WS-SD-S1	WS-L-S1-CL	WS-L-S1-FR	N/A	N/A	N/A	
WS-6215-LED-Z10	WS-SD-S2	N/A	N/A	WS-L-S2-MP-CL	WS-L-S2-MP-FR	N/A	
WS-6215-LED-Z10-DW	WS-SD-S2	N/A	N/A	WS-L-S2-MP-CL	WS-L-S2-MP-FR	N/A	
WS-6215-LED-ELV-1	WS-SD-S2	N/A	N/A	WS-L-S2-MP-CL	WS-L-S2-MP-FR	N/A	
WS-6215-LED-ELVT-1-DW	WS-SD-S2	N/A	N/A	WS-L-S2-MP-CL	WS-L-S2-MP-FR	N/A	
VARIAL™							
WS-6230-HAL	WS-SD-S1	WS-L-S1-CL	WS-L-S1-FR	N/A	N/A	N/A	
WS-6230-LED-ELV-1	WS-SD-S2	N/A	N/A	WS-L-S2-MP-CL	WS-L-S2-MP-FR	N/A	
WEDGE LENS™							
WS-7215-HAL	WS-SD-S3	WS-L-S3-CL	WS-L-S3-FR	WS-L-S3-MP-CL	WS-L-S3-MP-FR	WS-L-S3-DP-CL	
WS-7215-LED-ELV-1	WS-SD-S3	N/A	N/A	WS-L-S3-MP-CL	WS-L-S3-MP-FR	WS-L-S3-DP-CL	
DOUBLE WEDGE LENS™							
WS-7230-HAL	WS-SD-S4	WS-L-S4-CL	WS-L-S4-FR	WS-L-S4-MP-CL	WS-L-S4-MP-FR	WS-L-S4-DP-CL	
WS-7230-LED-ELV-1	WS-SD-S4	N/A	N/A	WS-L-S4-MP-CL	WS-L-S4-MP-FR	WS-L-S4-DP-CL	
ADA WEDGE™							
WS-8815-HAL	WS-SD-S1	WS-L-S1-CL	WS-L-S1-FR	N/A	N/A	N/A	